

MAY 1972

HEWLETT-PACKARD JOURNAL

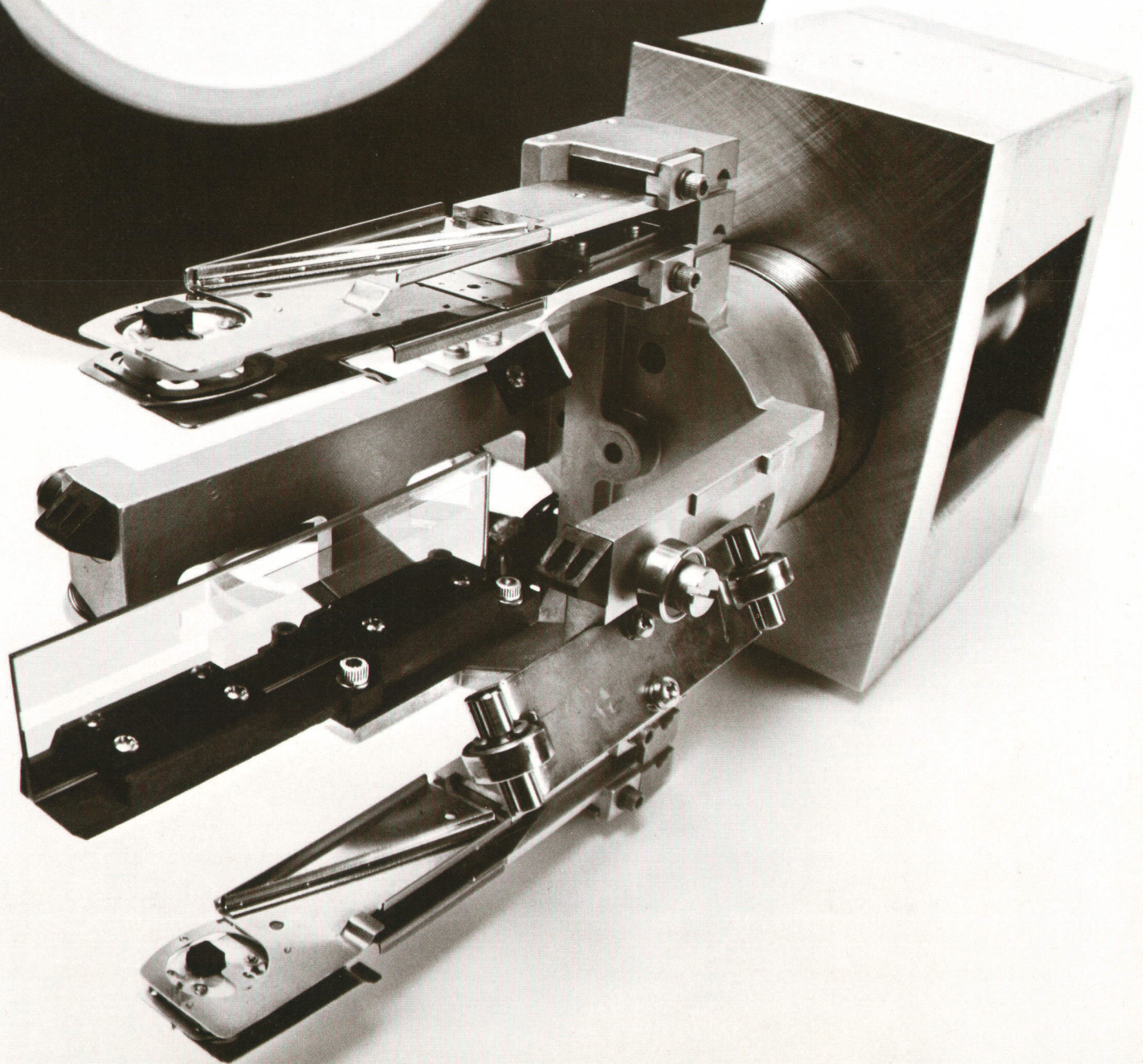

A Faster, Tougher Disc Drive for Small Computer Systems

Here's a high-performance cartridge disc drive that doesn't have to be treated like a baby. It's the only peripheral storage device most small computer systems need.

By James E. Herlinger and James R. Barnes

DESIGNING AND PRODUCING DISC DRIVES isn't the sort of venture a company embarks upon unless the expected benefits outweigh the substantial investment in time, money, and manpower that's required. When Hewlett-Packard decided two years ago to develop its own disc drives, it was for the same reason that had led to in-house production of a series of small, rugged tape drives a year earlier, and to HP's first computer some years before that. There simply were no *instrument-quality* disc drives available commercially.

HP instruments and computers are expected to operate reliably in a wide range of environments, from the cold dampness of a ship on the North Atlantic to the dry heat and vibration of a truck on the New Mexico desert. Ideally, the disc drive that provides on-line mass data storage in an HP computer-controlled instrumentation system should be able to operate under these same conditions.

The principal contribution of HP's new 7900-Series Disc Drives is that they can operate under conditions that have been considered too severe for disc drives. However, there are other major contributions, too. The new drives have the fastest access time and the fastest data transfer rate of any cartridge disc drive, fast enough so they can serve as the only peripheral memory device in real-time and time-sharing systems such as the HP 9625C Real-Time Executive System and the HP 2000E Time-Shared Computer System. (In the 2000E a 7900A Disc Drive replaced the fixed-head-per-track disc drive formerly used.) A conservative, well-tested mechanical and electrical design, including safety circuits and interlocks, assures long periods of reliable operation with minimal service. The drives are compact, but have comparatively large data storage capacity.

Two Versions

7900-Series Disc Drives are small moving-head front-loading interchangeable-cartridge drives, the type of drive best suited for most applications of HP systems. There are two versions. Model 7900A (Fig. 1) has one fixed disc and a removable disc cartridge which together have a capacity of five million bytes (40 million data bits). Model 7901A has just the removable cartridge. Most parts and technology are common to both drives.

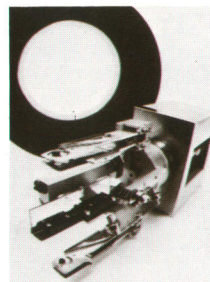

Cover: *This is the fast, precise linear-motor actuator and head-carriage assembly that moves the read/write heads in Model 7900A Disc Drive. The upper set of heads is for the removable cartridge and the lower set is for the fixed disc.*

In this Issue:

- A Faster, Tougher Disc Drive for Small Computer Systems, by James E. Herlinger and James R. Barnes* **page 2**
- Inside the 7900 Disc Drive, by James E. Herlinger and William J. Lloyd . . .* **page 6**
- Reading and Writing on the Fast Disc, by William I. Girdner and Wallace H. Overton* **page 12**
- An Efficient Disc Drive/Computer Interface, by Donald J. Bowman* **page 15**
- Narrowband Noise Immunity in a Broadband Gain-Phase Meter, by Raymond C. Hanson* **page 17**

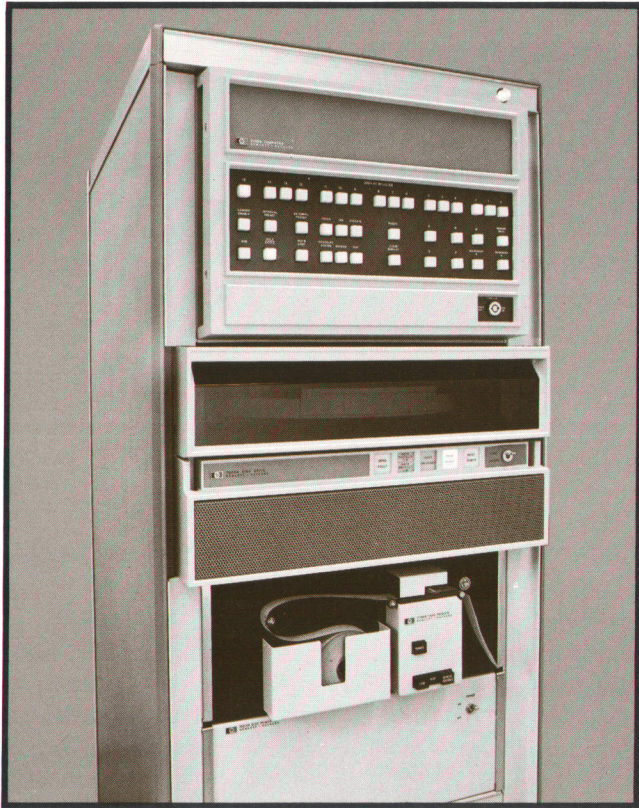

Fig. 1. Model 7900A Disc Drive operates in environments too severe for other drives. It's also fast for a small moving-head drive: average seek time is 30 ms, average latency is 12.5 ms. Data transfer rate is 312,000 bytes per second. Capacity on one fixed disc and one removable cartridge is 5 million 8-bit bytes.

For more on-line storage capacity, up to four drives can be operated from a single controller. The four drives can include any combination of 7900A's and 7901A's. Off-line storage on additional cartridges is unlimited, of course, and it takes less than 60 seconds to stop, change cartridges, and resume full operation.

Both drives operate in ambient temperatures between +10°C and +40°C, and tolerate relative humidity between 8% and 80%. A disc written on any 7900-Series drive anywhere within this range can be read on any other 7900-Series drive operating within this range. Positioning accuracy of the heads isn't affected by moderate amounts of vibration or by pitch and roll up to $\pm 30^\circ$. Special isolation and power line filtering minimize noise and electromagnetic interference that might cause data errors. Submicron air filtration keeps out microscopic particles that might cause damage to the disc or the read/write heads.

In Model 7900A, positive air pressure is maintained during a cartridge change to keep dust away

from the fixed disc. (In Model 7901A this isn't required since there's no fixed disc.) Model 7901A has an integral power supply; Model 7900A's is separate.

Fast Access Time

The new disc drives get their fast access time primarily from an HP-developed linear-motor actuator which moves the heads. Total access time of a moving-head disc drive is the sum of seek time and latency or rotational delay. Seek time is the time it takes to position the read/write heads over the desired track on the disc. Latency, or rotational delay, is the time required for the disc to rotate so the desired data is underneath the heads.

In the 7900A the average single-track seek time, or the time to move from one track to the next, is 7 milliseconds. The average random move, defined as the time required to perform all possible seeks divided by the number of possible seeks, takes less than 30 milliseconds. This is very fast for a moving-head disc drive. A maximum move of 202 tracks takes less than 55 milliseconds. For the 7901A, the corresponding figures are 10 ms, 35 ms, and 65 ms, respectively. In both models, the disc rotates at a rate of 2400 revolutions per minute, so rotational delay is a maximum of 25 ms and averages 12.5 ms.

Transferring Data

Access time is only one component of the overall data throughput rate of a disc drive. Also important is the time it takes to transfer data into or out of the drive. Data transfer rate depends on rotation rate and recording density. The new drives' instantaneous data transfer rate is 312,000 8-bit bytes or 2.5 million bits per second. To attain this high rate the drives use an inner-track recording density of 2200 bits per inch and a rotation rate of 2400 rpm.

Each recording surface has 200 tracks (plus three spare tracks), and each track is organized into twenty-four 256-byte sectors. The maximum data transfer rate of 2.5 million bits per second is realized when reading or writing within any single sector.

Block Transfers in Systems

The implications of fast access time and high data transfer rate for system operation can be seen best in an example. In the HP 5407A Scintigraphic Data Analyzer a 7900A Disc Drive is used to transfer a 1.25-million-word record at an average data transfer rate of 82,000 words per second. First, sectors 0 through 15 on track 0 are transferred and the heads are moved to track 1. This requires 16.7

About Disc Drives

A disc drive is an external memory device for digital computers. It is so named because the medium it uses to store information is an aluminum disc slightly larger than a standard long-playing phonograph record. Bonded onto both sides of the disc is a ferromagnetic iron oxide suspended in an organic binder. The iron oxide has magnetic characteristics similar to magnetic tape.

To write data onto the disc, transducers called heads are used. These same heads are also used for reading data that has been previously written. The disc rotates at high speed and the heads actually fly over the disc surface, never contacting it. The flying altitude is very low—only one-thirtieth the diameter of a human hair—so it's very important to keep dust particles and other contaminants out of the system so they don't get between the head and the disc where they might cause damage. High-efficiency filters and a high-flow-rate blower do this job.

The head consists of a loop of magnetic material, called a core, which has coils of wire wrapped around it. There's a small gap in the core, directly over the disc. When current is sent through the wire coils a magnetic field is induced in the core. The field stays inside the core except at the gap, where it fringes, or bends, toward the disc. This fringing flux can magnetize a local area of the disc surface without physical contact. Data is written on the disc by magnetizing the disc surface in a varying pattern.

Reading previously written data is the reverse of the writing process. The magnetic pattern on the disc surface induces a varying magnetic field in the head which causes current to flow in the coils of wire around the head core. Electronic circuits then extract the data from this current.

Data is stored on the disc in concentric tracks. A vast

amount of data can be stored. One disc cartridge can store an amount of data that, if put on Hollerith (IBM) cards, would fill a stack over 17 feet high!

In the world of computer memories, disc drives occupy their own well-defined niche. The average access time of a disc drive, or the average time it takes to retrieve data stored on the disc, is slower than that of the core or semiconductor memory commonly used in computer mainframes, but it's much faster than magnetic tape. On a cost-per-bit basis, disc drives fall between core and tape—they're less costly than core and more expensive than tape. This middle-ground combination of cost and performance wins disc drives wide acceptance as peripheral data storage devices in computer systems.

The fastest disc drives are fixed-head-per-track drives, which have multiple read/write heads for each disc surface. The other major type of disc drive is the moving-head, interchangeable-cartridge type, which usually has only one head per disc surface. Moving-head drives, like tape transports, have essentially unlimited storage capacity, because the disc cartridge, like a reel of tape, can be removed and another cartridge containing different data inserted. Fixed-head-per-track drives have faster access time because they can switch tracks on the disc in only microseconds, whereas it takes milliseconds to move the heads in a moving-head drive. However, for a given storage capacity, the cost of a fixed-head drive is almost ten times that of a moving-head drive because of the large number of heads it uses.

The new HP Model 7900A and 7901A Disc Drives are small moving-head interchangeable-cartridge drives. The table shows where these drives fit in the hierarchy of computer memories.

Hierarchy of Read/Write Memories

	Semiconductor Memories	Core	Small Fixed-Head Discs	Large Fixed-Head Discs	Small Moving-Head Discs	Large Moving-Head Discs	High Speed Magnetic Tape	Low Speed Magnetic Tape	Laser* Memory	Micro* Film
Access Time (μ s)	0.2-0.75	0.3-0.5	10k-20k	5k-20k	20k-100k	20k-100k	5k-10 ⁸	15k-10 ⁹	1k-8M	
Transfer Rate M Bytes/s	1.3-4	1-2	0.1-0.4	0.25-3	0.1-0.3	0.3-0.8	0.06-0.3	0.01-0.06	0.38	
Cost/Bit (cents)	0.7-2	0.7-0.4	0.1-0.2	0.05-0.1	0.01-0.008	0.01-0.003	0.006-0.002	0.003-0.001	0.0002	0.0001
Capacity (Bits/Unit)	1k	64k-2M	0.5M-8M	10M-50M	20M-100M	100M-800M	50M-300M	50M-300M	10 ¹²	300M-1500M
Approximate Total Cost for 10 ⁶ Bits, without Controllers or Drivers (=10 ⁶ × Cost/Bit)	\$10k	\$6k	\$1.5k	\$800	\$90	\$60	\$40	\$20	\$2	

*Read only

milliseconds for data transfer and 7 milliseconds for seek time—a total of 23.7 ms, less than the time of one disc revolution (25 ms). After a 1.3-ms wait, sectors 0 through 15 on track 1 are transferred and the heads are moved to track 2. This is repeated for all 200 tracks. The process is then repeated in reverse, transferring sectors 16 through 23. The system then switches heads (this takes only a few microseconds) and transfers sectors 0 through 7,

then 8 through 23 on the other disc surface.

This ability to transfer large blocks of data rapidly enables these moving-head disc drives to replace fixed-head-per-track drives in many systems. The high data transfer rate also minimizes the amount of the computer's core memory that has to be used as a disc-drive input/output buffer.

Another important consequence of the high block data transfer rate and the dual-disc design of Model

7900A is the ability to make a backup copy of the data in the system in a very short time. Data can be transferred from the fixed disc to the removable disc or vice versa in a matter of seconds.

Design Details

Details of the design of the new disc drives and implications for the user are contained in the articles which follow.

Acknowledgments

The authors of all four disc drive articles in this issue wish to acknowledge the many contributors that have made the 7900 series a reality. Development of the new drives was truly a team effort. The resources of virtually the entire corporation were used. Santa Clara Division's laser interferometer was used extensively throughout the program. Medical Electronics Division provided support in transducer development. Personnel in the model shops of Gordon Smith and Bill Merg provided intricate parts accurately and quickly. Glen Herreman and his metrology lab staff performed the precise mea-

surements required to verify positioning accuracy.

Special thanks go to the project teams: Frank Berry, who designed the airflow system and the optical transducer; Dick Bixler, software and the disc service unit; Rick Davidson, optical transducer and head mounting; Kevin Douglas, overall package responsibility; Ron Morgan, project coordinator; Art Sobel, circuit design; Kail Peterson, industrial design; Bob Ritter, diecast carriage and many of the molded parts; Herb Stickel, designing of parts where major tooling investments were required; Chuck Tracy, power supply; Jack Wernli, motion control and interlock electronics; and Dennis Edson, Earl Garthwait and John Miller, flying head design and development. Tooling support was ably provided by Lyle Loeser, Orland Upton, Tom Thompson and Roland Krevitt. Ed Churka and Marc Nilson provided excellent technician support for the two projects.

In conclusion, we wish to acknowledge the many contributions of Papken Der Torossian, disc section manager, whose insight and guidance were invaluable and indispensable. 🍷

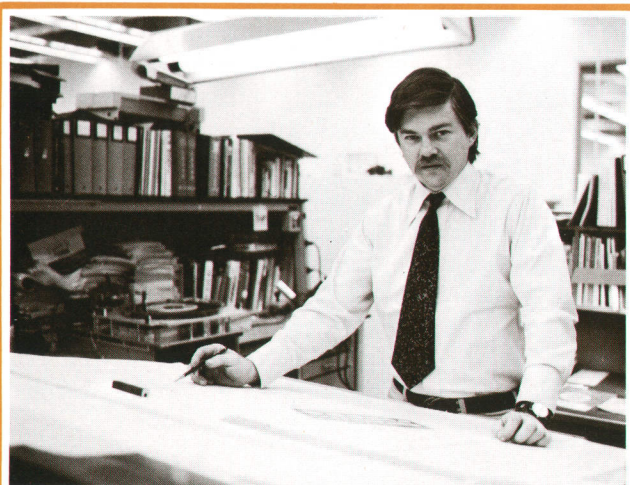

James E. Herlinger

Mechanical engineer Jim Herlinger was the first 7900A project leader. He started with HP on a part-time basis in 1960 while working for his BSME degree at Stanford University. After he graduated in 1963 he spent two years in Ford Motor Company's graduate training program, working mostly in Ford's race car programs, and taking business courses part-time at the University of Michigan. In 1965 he returned to HP to stay. Racing and automobiles have been in Jim's blood for a long time. He's driven in local and international sports car races and is presently building a car to compete in the Sports Car Club of America's B/SR class (it's a Brabham BT8 with a Porsche 911 engine). Jim's now combining business with his major interest; he's market manager concerned with uses of data acquisition systems for automobile engine testing.

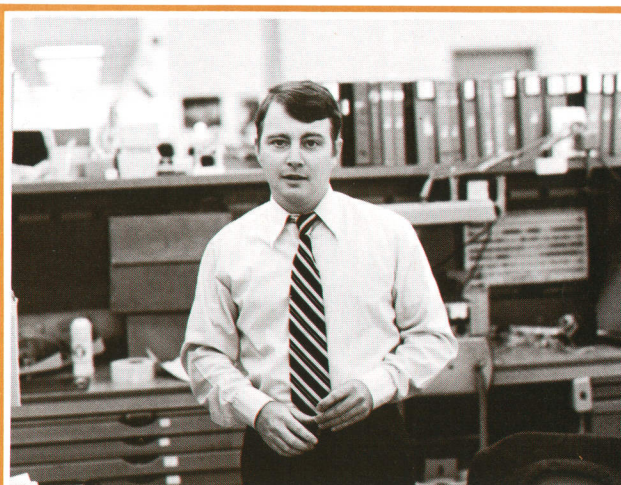

James R. Barnes

Jim Barnes, 7901A project manager, holds BS, MS, and Engineer degrees in mechanical engineering, the first received from Stanford University in 1960 and the last two from California Institute of Technology in 1964 and 1966. This year he received an MBA degree from the University of Santa Clara. Jim served as a U. S. Navy Lieutenant before coming to HP in 1964 to work on X-Y recorder design. He switched to magnetic recording in 1969 and helped design the 3960A portable analog tape recorder before assuming his present job. Jim's an avid football fan during the autumn, and on summer weekends he and his family board the power cruiser they've restored and head for the Sacramento River delta for fishing, swimming, and just taking it easy.

Inside the 7900 Disc Drive

Here's what makes it fast, accurate, rugged, and reliable.

By James E. Herlinger and William J. Lloyd

MANY OF THE OBJECTIVES for the 7900-Series Disc Drives posed formidable design problems. To be useful in real-time systems the access time and data transfer rate had to be as fast as possible. To conserve rack space and to be compatible with standard HP racks the drives were to be small and fit into a 25-inch-deep rack. To meet the wide variety of needs of HP customers, the drives had to be able to operate in the same severe environments HP instrumentation systems are designed to withstand. Before the 7900 Series, no disc drive in the industry could meet these environmental specifications, primarily because of the operating temperature range of 10°C to 40°C. What's more, the drives were to operate for five years or more with no major adjustments or service.

Positioning the Heads

Accuracy was of prime importance in the design of the head-positioning system, and the 10°C to 40°C temperature range was a complicating factor. Since the disc cartridge is removable, any 7900-Series drive must be capable of reading data written on any other, even one operating at the opposite extreme of the environmental range. The tracks on which data is recorded are spaced just 0.010 inch apart, or about three times the thickness of a human hair. To guarantee interchangeability the heads must be located within ± 0.0015 inch of the nominal track location under all specified environmental conditions.

There are many elements in the tolerance loop which compete for part of the 0.0015 inch total allowable error. Errors are induced by spindle run-out, thermal effects, hysteresis in the servo system, and external disturbances. A design objective was a

positioning system which used no more than one-fifth of the total system tolerance, or 0.0003 inch maximum error at any time.

Actuator Design Was Critical

The major design task was the actuator which moves the heads. The actuator has to move the head-carriage assembly rapidly and precisely along a radius of the disc. To meet the speed requirements the moving parts had to be very light and have a high mechanical resonance frequency. To fit in a 25-inch-deep cabinet, the actuator assembly had to be as short as possible while providing a useful travel greater than three inches.

The sometimes-incompatible objectives of extreme precision and high speeds were met by a linear-motor, or 'voice coil' actuator design (Fig. 1). Its principle of operation is based on the phenomenon that current flow in a coil of wire which is placed in a magnetic field produces a force which tends to move the coil in a direction orthogonal to both the current vector and the magnetic field vector. This is the same principle that's used in a loud-speaker; hence the name 'voice coil.'

High-energy-product alnico magnets provide the magnetic field for the linear actuator. For a given size, this magnet material has the strongest field available; therefore it minimizes the length of the motor. The soft iron end plates and center poles are operated well below saturation levels to provide a low reluctance path for the magnetic flux, thereby allowing the highest possible efficiency. Aluminum wire was chosen for the voice coil to minimize the moving mass. Wire size and coil current were optimized to produce the desired force with low input power. Fast current risetime was realized by de-

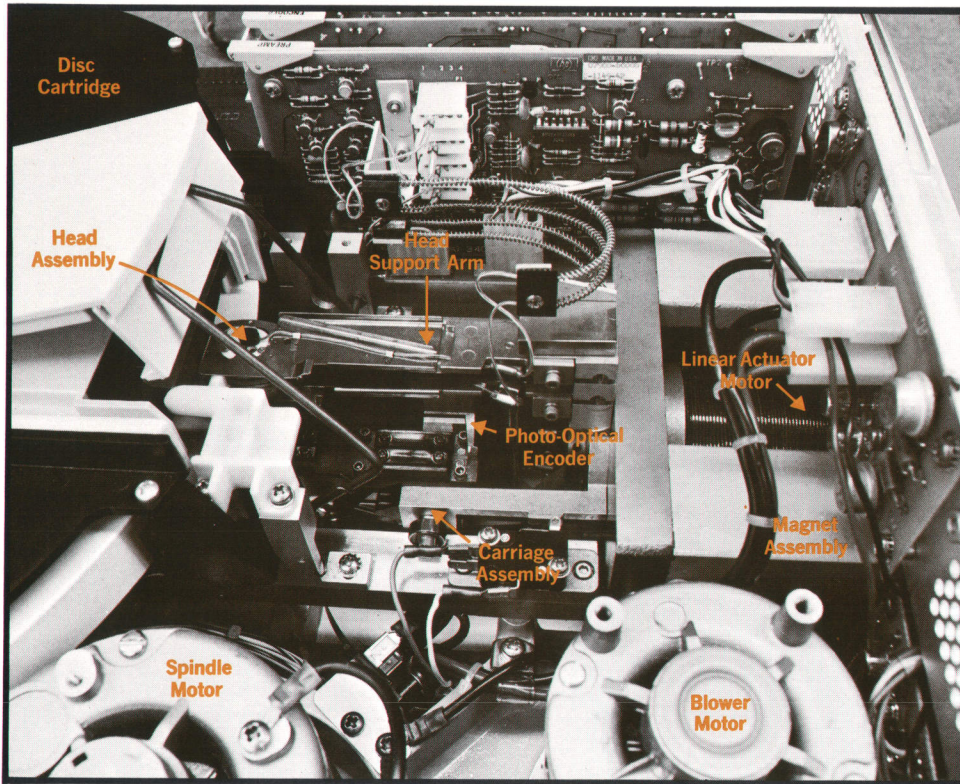

Fig. 1. Read/write heads in Model 7900A Disc Drive are moved by a fast linear-motor actuator. A 202-track maximum-length move takes less than 55 ms.

signing the unit for minimum inductance. The coil is wound on a glass-reinforced epoxy tube and permanently bonded to a die-cast aluminum carriage.

The voice coil approach has worked well. It is compact, it provides linear motion directly (i.e., no conversion of rotary to linear motion is required), and it is fast (a two-inch move in less than 55 milliseconds). Other advantages are low moving mass, which keeps the power requirements within reason, and compatibility with a high-gain servo system, which results in a very stiff system. The actuator system requires a minimum number of components and is relatively inexpensive to produce.

Stiff, Accurate System

The linear-motor actuator is controlled by a multimode servo system (see block diagram, Fig. 2). High gain and broad bandwidth make the electromechanical system quite stiff—10 pounds per 0.001 inch displacement. Stiffness is important in minimizing carriage settling time, hysteresis errors, and errors from external sources. The read/write heads are held in position regardless of the attitude of the drive, and a 3g bump to the drive will move the head carriage no more than 0.0003 inch. Thus system stability is assured and the drive is solid enough for mobile applications.

The system is extremely accurate. If there is no vibration, the system locates the heads within 0.0001 inch, and even with moderate vibration, the design goal of a 0.0003-inch maximum total error is still not exceeded.

Despite its high gain, the servo amplifier has excellent temperature stability. Maximum drift over the 10°C to 40°C operating temperature range is equivalent to less than 10 microinches displacement of the read/write heads.

When a seek command is issued to the drive by the computer, the desired track address is clocked into the cylinder address register. A subtraction circuit determines the difference between the instantaneous carriage position and the desired position and presents to the velocity curve generator a binary representation of the difference. The velocity curve generator converts this information to an analog voltage proportional to the square root of the distance to be moved, and the voltage causes the carriage to move. Motion is rapid when the distance to be moved is large (>63 tracks = maximum speed) and progressively slower as the heads approach their destination. The square root function is used because, for constant deceleration, velocity is proportional to the square root of the distance to be moved.*

* $v^2 = 2ax$, so for constant deceleration a , $v = k\sqrt{x}$.

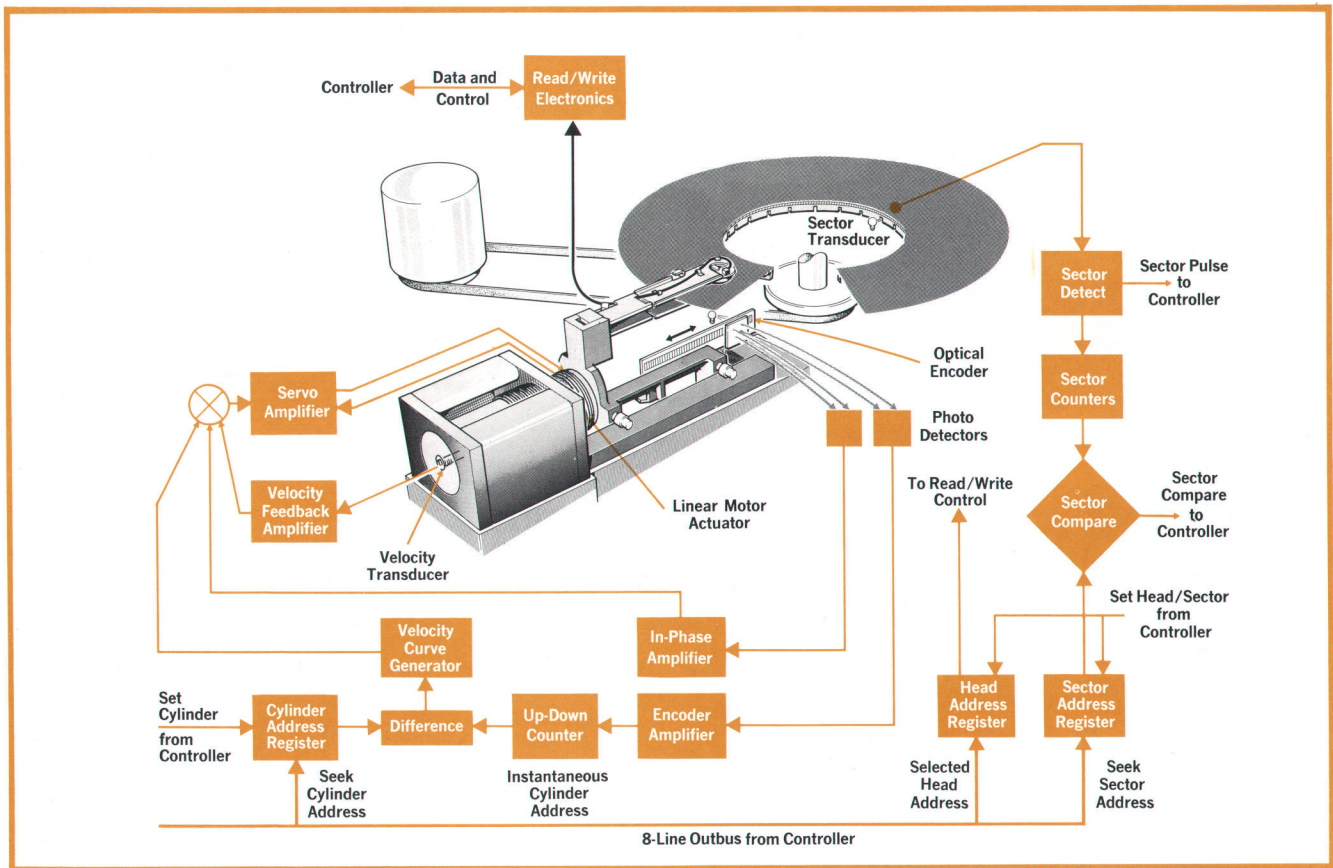

Fig. 2. Servo system locates the read/write heads within 0.0003 inch of track center and holds them there with a stiffness of 10 pounds per 0.001 inch. Servo stiffness resists vibration and shock in mobile installations. Safety circuits and interlocks protect drive and data.

Precise Positioning with Optical Encoder

Carriage position detection is the job of an optical encoder (Fig. 3). The encoder provides two channels of position information separated by one-quarter track. The encoder outputs are produced by sensing light from a fixed source through a reticle and encoder plate. The encoder plate is mounted on the carriage and is etched with a series of mask bars, one for each track on the disc. The bar separation exactly represents the 0.010-inch track-to-track separation. There are two sets of mask bars, offset by one-quarter track, and a separate detector senses the light passed by each set. Thus the two detector outputs have a 90° phase difference which changes direction depending upon which way the carriage is moving.

Position and direction information from the optical encoder is applied to an 8-bit up-down counter which functions as an instantaneous address register. This counter always contains the actual carriage position.

Along with the position feedback, the servo loop also includes velocity feedback. This feedback is

derived from an HP-designed velocity transducer which has a usable stroke of three inches although it is only 4.6 inches long.

Fig. 4 shows the velocity profile for repetitive seeks between tracks 0 and 202. The cleanness and absence of overshoots illustrate the effectiveness of the control system.

Safety Circuits Prevent Damage

Because safety of data and drive was a prime consideration, the design of the 7900 Series is very conservative. An example of the many safety features is the track-center detector, a circuit which detects any significant deviation (approximately 400μin) of the heads from track center. The output of this circuit is used to prevent inadvertent destruction of data on adjacent tracks in the event of any malfunction or external force which moves the head off the center of the track.

Read/write malfunction detectors will shut down the drive if any of seven conditions occur which could destroy recorded data or record data improperly. These conditions include controller errors and

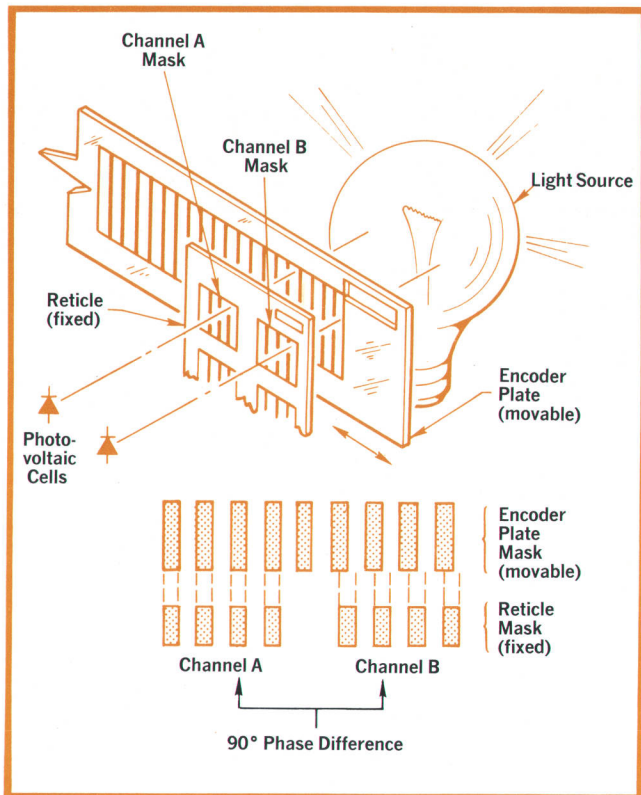

Fig. 3. Optical encoder senses location and direction of read/write heads. Head position and destination are both available in registers at all times.

drive hardware failures. The type of fault is stored in a seven-bit memory to aid in tracking down a transient failure. Other safety circuits include over-voltage and overcurrent protection and sequence timing controls. The operator cannot damage the drive with external inputs. There are no duty-cycle restrictions on accessing. Zero-crossing detectors for ac power control prevent line transients. Write protection is switch-selectable from the front panel.

The read/write heads are normally retracted from the disc under control of the servo system. Should sensing circuits detect a malfunction of the motion control system, the actuator coil is transferred to the five-volt power supply for retraction. In the event of a power failure, a nickel-cadmium battery is switched into the circuit to retract the heads. When primary power is restored to the system, the disc drive will automatically cycle through the power-up sequence and come on line without operator intervention.

An eddy-current damper and a mechanical detent prevent the heads from moving onto the disc surface when power is removed. The detent and damper will keep the heads away from the disc in the presence of shock or vibration up to 1 g. This

means one can stand the drive on end and the heads will not move onto the disc surface. With power off, the nickel-cadmium battery supplies current to retract the voice-coil actuator whenever the carriage moves more than a few tenths of an inch from its fully retracted position. This further guarantees that the heads will not contact the disc.

Interlock circuitry shuts off the drive motor or prevents its starting if any of several improper conditions exist. The interlocks assure, for example, that the door is locked, that no printed-circuit boards are missing, that the power supplies and the encoder lamp are operating, and that the removable disc cartridge is properly seated on the spindle.

Noise and Interference Can't Get In

7900-Series drives are designed to operate in areas which have a large amount of electromagnetic interference. A line filter in the power supply removes severe line transients. Provision for electrically isolating the disc drive from the cabinet rack is incorporated in the chassis slides. This is accomplished without sacrificing grounding of all operator-accessible controls. The front-end frame assembly is grounded to the rack rather than to the main casting which is the disc system ground. Thus the disc system can be isolated for added protection from noise, such as that from static charges produced by walking on carpeted floors.

Lots of Air

Air flow is essential to a disc drive. Carriage-location errors caused by thermal offsets can be minimized by passing a large quantity of cooling

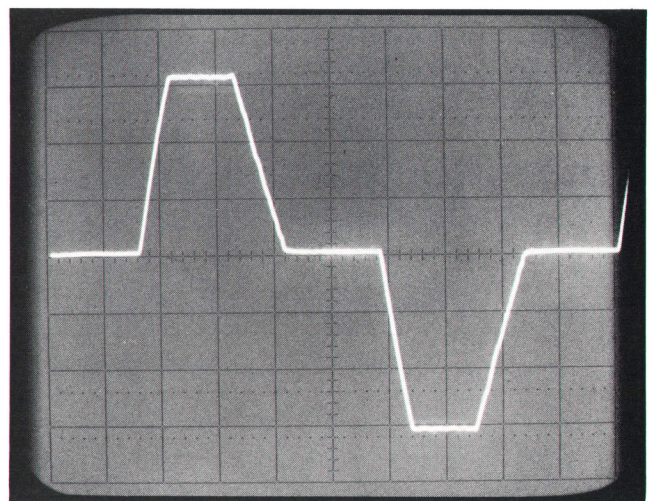

Fig. 4. Velocity profile of heads for moves between tracks 0 and 202. Absence of overshoots shows effectiveness of control system.

air through the disc drive. This large quantity of air will also quickly bring a newly inserted cartridge up to operating temperature.

An additional job required of the air-flow system is that of cleaning the air before it is introduced to the cartridge or the fixed disc. The heads fly over the disc at a height of 65 to 90 microns. Any particle in the air system must be eliminated or it may cause problems. The heads may encounter a particle and skip over it, causing data errors, or even worse, the particle may scratch the disc or head. A scratch can cause a snowballing effect which may ruin the head and will almost certainly ruin the disc.

To minimize the chance of dirt getting into the disc drive, two filters are used. A coarse filter of open-cell polyurethane foam is behind the front screen air intake, and an absolute filter is on the high pressure side of the squirrel-cage blower (Fig. 5). The absolute filter is a woven glass asbestos filter which traps virtually all particles 12.5 microns ($0.3\mu\text{m}$) and larger.

To minimize leaks and duct noise many of the air-flow passages were formed into the main casting. Because this casting was formed in sand it is painted with polyurethane paint to eliminate the possibility of sand particles becoming dislodged and damaging the system.

Little Attention Required

Service and life objectives were defined early in the disc drive program. The drives are designed to minimize assembly and maintenance time. Mechanical components are precisely machined on numerically controlled machine tools so no critical adjustments are required during assembly or field maintenance. The carriage and ways are assembled and fastened into place.

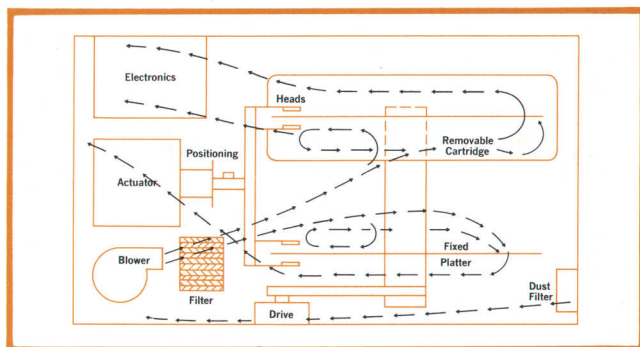

Fig. 5. A high volume of air flow equalizes temperatures quickly when a cartridge is changed. Absolute air filtration keeps out microscopic particles. The drive is designed to have a five-year life with no major adjustments or service.

Care was taken to minimize the electrical adjustments, and the only mechanical adjustment is the fore/aft position of the two heads for the disc cartridge. These heads must be aligned to assure interchangeability of cartridges. All other mechanical assemblies are built with sufficient precision that they can be assembled or replaced without adjustment.

Reliability Thoroughly Tested

All of the prototype phases of the 7900-Series design, as well as a pilot-run and a production-run machine, have been subjected to normal HP environmental testing. However, environmental testing is insufficient for studying detailed electrical performance characteristics of a product or the life of a mechanical system. Consequently, the new drives were subjected to extensive special testing.

Of major importance in a disc drive is the data error rate. The objective for the 7900 Series was one soft error in 10^{10} bits of data transferred. A soft error is considered a recoverable error. If an error in a data pattern is detected the drive is instructed to re-read the record and the mistake is noted as a soft error. If the record cannot be read after three attempts, the error is considered a hard error and a failure of the disc drive. Reaching the goal of one soft error in 10^{10} bits and no hard errors required a major engineering effort.

It was important to interface the disc drive to a computer very early in the development program. A comprehensive diagnostic program was developed to test the drive in nearly every way imaginable. The program writes hard-to-recognize bit patterns, causes random seeks and incremental seeks, and in general, thoroughly exercises the drive and controller/interface. More than 10,000 hours of run time have been accumulated on various drives in error-rate studies, and many subtle design problems have been eliminated. Still, every production drive must run for 20 hours on the diagnostic program prior to being shipped.

Tests were also performed to see that the drive would meet the objective of a five-year useful machine life with no major mechanical adjustments or service. Users of moving head disc drives indicated that 50,000 accesses a day could reasonably be considered a worst-case application. 50,000 accesses a day every day for five years required a head-positioning assembly capable of making 100 million accesses with no adjustments or service.

Early in the project several actuators were set up and subjected to life tests. It requires months of continuous accessing to accumulate 100 million

cycles. Once a final combination of bearings, ways, coil leads, and head lead springs was chosen a system was run for ¼ billion cycles without a failure.

The most severe test of a spindle or electrical motor is starting and stopping. When a spindle comes to a halt most of the lubricant is squeezed from beneath the ball bearings before it starts up again. 7900 Series Disc Drives have been operated

for the equivalent of 75 starts and stops a day for five years with no malfunctions.

The heads are loaded onto the disc by sliding the head arm off a ramp at a controlled rate as the carriage moves towards the disc. To check that no damage to the heads or disc surface would occur a head was loaded on and off the same disc 500,000 times. This is equivalent to changing a cartridge ten times an hour for five years. 



William J. Lloyd

Bill Lloyd is the present 7900A project manager. He joined HP in 1969 with a background in the design of servo systems for satellite tracking antennas and for the Apollo moon program communications antennas. His HP design contributions include work on the 7970A Magnetic Tape Transport and the actuator and servo systems for the 7900A Disc Drive. He's applied for a patent on the disc drive's velocity detecting apparatus. Bill's an outdoorsman who enjoys camping, fishing, and hiking with his sons, and serves as a crew member on a friend's Spalding 33 in yacht races. He expects to complete work for his MSEE degree at Stanford soon. His BSEE degree is from the University of California at Los Angeles.

SPECIFICATIONS
HP Model 7900A
Disc Drive

TYPE: Moving-head dual disc drive
One removable cartridge, front loading
One fixed disc.

DATA CAPACITY: Approximately 48 million bits (40 million data bits) when in 24-sector format.

DATA DENSITY: 2200 bits per inch.

TRACK DENSITY: 100 tracks per inch.

DATA TRANSFER RATE: 2.5 million bits per second.

SPINDLE SPEED: 2400 rpm.

HEAD POSITIONING TIMES (including head settling):
Adjacent Cylinder Move: 7 milliseconds average.
Random Move*: 30 milliseconds average.
200 Cylinder Move: 55 milliseconds maximum.

OPERATING ENVIRONMENT:
Temperature: 10°C to 40°C.
Altitude: 0 to 10,000 ft.
Humidity: 8% to 80%.
Attitude: ±30° pitch and roll.

POWER REQUIREMENTS: HP 13215A Power Supply or equivalent.

DIMENSIONS: 19 in (48.3 cm) wide, 10½ in (26.7 cm) high, 25½ in (65.1 cm) deep. Width behind panel, 16¾ in (42.5 cm). Depth behind panel, 22½ in (58.3 cm). Fits Standard 19-inch EIA rack.

WEIGHT: 117 lb (53.1 kg)

PRICE IN U.S.A.: \$9975 including HP 13215A Power Supply and disc cartridge.

HP Model 13215A
Power Supply

DIMENSIONS: 16¾ in (42.5 cm) wide, 7 in (17.8 cm) high, 19¾ in (50.2 cm) deep. Fits standard 19-inch EIA rack.

WEIGHT: 55 lb (25 kg)

POWER REQUIREMENTS:

Voltages	50 Hz ±2%	60 Hz ±2%
100 ±10%, 1Φ	4.9 A	4.1 A
120 ±10%, 1Φ	4.1 A	3.4 A
200 ±10%, 1Φ	2.4 A	2.0 A
220 ±10%, 1Φ	2.2 A	1.9 A
240 ±10%, 1Φ	2.0 A	1.7 A

HP Model 7901A
Disc Drive

TYPE: Moving-head disc drive
One removable cartridge, front loading

DATA CAPACITY: Approximately 24 million bits (20 million data bits) when in 24-sector format.

DATA DENSITY: Same as 7900A.

TRACK DENSITY: Same as 7900A.

DATA TRANSFER RATE: Same as 7900A.

SPINDLE SPEED: Same as 7900A.

HEAD POSITIONING TIMES (including head settling):
Adjacent cylinder move: 10 ms average.
Random move*: 35 ms average.
200-cylinder move: 65 ms maximum.

OPERATING ENVIRONMENT: Same as 7900A

POWER REQUIREMENTS:

Voltages	50 Hz ±2%	60 Hz ±2%
100 ±10%, 1Φ	4.1 A	3.4 A
120 ±10%, 1Φ	3.4 A	2.8 A
200 ±10%, 1Φ	2.0 A	1.7 A
220 ±10%, 1Φ	1.8 A	1.6 A
240 ±10%, 1Φ	1.7 A	1.4 A

DIMENSIONS: Same as 7900A.

WEIGHT: 107 lb (48.6 kg).

PRICE IN U.S.A.: \$6 000.



MANUFACTURING DIVISION: DATA PRODUCTS GROUP
11000 Wolfe Road
Cupertino, California 95014

*Random Average Seek Time is Defined as Follows: Time Required to Perform All Possible Seeks Divided by Number of Possible Seeks.

Reading and Writing on the Fast Disc

Specially designed wide-temperature range heads and a phase-locked loop help guarantee reliable data transfer.

By William I. Girdner and Wallace H. Overton

IN 7900-SERIES DISC DRIVES, data is written serially on each track, one bit at a time, at high speed. It's the job of the data electronics and the read/write heads to encode the data, put it on the disc, and retrieve it when it's needed. The read/write circuitry has to transfer error-free data while accommodating not only disc-speed changes caused by variations in line voltage and frequency, but also drive-to-drive differences in head positioning and variations in disc magnetic characteristics.

Fig. 1 is a diagram of the read/write system. Double-frequency coding is used for recording data because this code is self-clocking when read from the disc. At the start of each bit cell on the disc, there's a magnetic flux transition that's used as a clock pulse. The presence or absence of another flux transition in the middle of a bit cell identifies the contents of that cell as a data '1' or data '0', respectively.

In the write electronics, each incoming transition switches the current between two data windings in the writing head. Electrically, the head consists of three Y-connected coils on a ferrite core. A voltage is applied to the center point of the Y to select whichever head is to be operational.

Two of the coils are phased such that current through them from the select point will create opposite-polarity magnetic fields at the writing gap. Switching the current between the coils reverses the fringing flux at the head gap and leaves the coded data transitions on the magnetic disc passing under the gap.

The third coil in the head is an erase coil which, by means of other gaps in the head structure, erases the edges of the just-written track and the area between tracks. This provides a tolerance for head positioning error and freedom from track-to-track

interference. It also eliminates old residual data.

Reading the Bits

Reading the data from the disc is done with the same head and windings that are used for writing. The select point now looks like an ac-grounded center tap, and the read data appears differentially across the data windings.

The head output is a 2.5-MHz sinusoid for a series of data 1's. The worst-case output voltage is one millivolt peak-to-peak at the inside tracks. A series of zeroes produces a 1.25-MHz output at approximately twice the voltage, and random data produces a combination of the two frequencies. Fig. 2 shows a 01011 bit pattern with its corresponding head output.

Between the head and the preamplifier are head-switching diodes and a FET switch that isolates the preamplifier input during write operations. The differential IC preamplifier is followed by a balanced four-pole low-pass filter which attenuates noise and unwanted harmonics.

The voltage output of a magnetic reproducing head is the derivative of the magnetic flux*. Since it's the flux transitions that represent data pulses on the disc, the data is contained in the peaks of the head output waveform. A balanced differentiator following the low-pass filter converts the peaks to zero crossings. A zero-crossing detector then creates, for each zero crossing, a logic-level pulse which is transmitted back to the controller.

Phase-Locked Loop

The double-frequency code is self-clocking (every bit cell starts with a pulse), but clock pulses are not

$$*e = N \frac{d\phi}{dt}$$

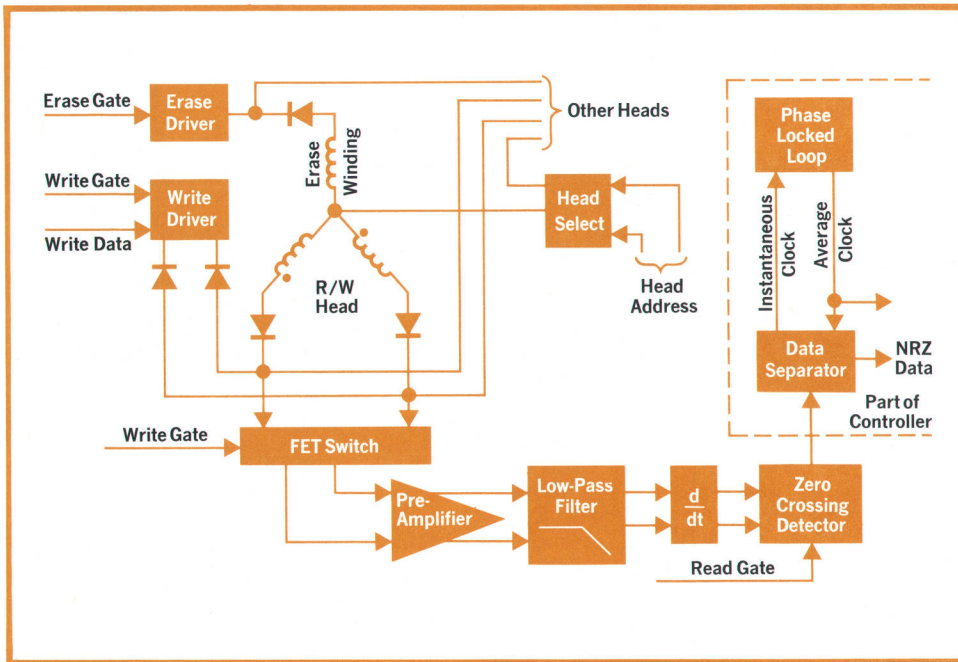

Fig. 1. Read/write circuitry has phase-locked loop to eliminate errors caused by pulse crowding and disc speed variations. Data separator decodes waveform received from read circuits.

directly available from data received by the data separator portion of the controller. The reason is a phenomenon called pulse crowding, or bit shift. A transition which is not bounded on both sides by transitions equidistant from it will be moved away from the closest transition by an amount proportional to the ratio of the distances to the adjacent transitions. The worst-case displacement is large enough to make it extremely difficult to separate clock and data.

In double-frequency coding like that used in the 7900 Series, the only transitions to be appreciably affected are clock transitions between zeros and ones. The data separator system in the controller uses a phase-locked loop to generate an accurate read clock, and a time window to detect the presence or absence of the data pulse signifying a '1'.

There are two reasons for using the phase-locked loop. First, the loop is locked to the clock pulses; however, the loop feedback is such that an average, rather than individual, clock position is held. This, along with the ones-catching window, eliminates pulse crowding as a problem. The other benefit of the phase-locked loop is the ability to handle disc speed variations. The disc speed will vary with line frequency and voltage and with environmental changes. Although the data is written at a crystal-controlled rate, the worst-case variations of write disc speed and read disc speed lead to a range of read clock rates.

Information is stored on the disc in serial coded form. Each sector begins with a field of zeros which

is used to synchronize the data-separation circuitry. In read operations, the phase-locked loop is enabled early in the zero field. The loop locks onto the zero field in time to be operating at the appropriate read clock rate for proper data separation. The 7900-Series drive-controller combination provides the best line frequency-voltage tolerance presently available.

Wide-Range Heads

The read/write heads (Fig. 3) are designed to fly

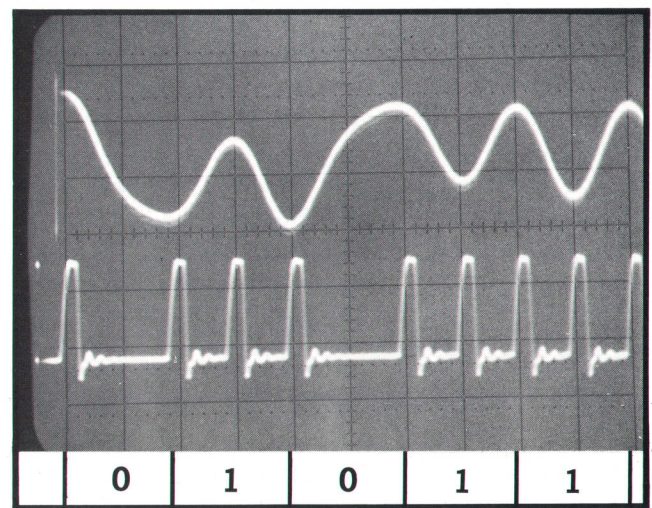

Fig. 2. Head output (top) is converted to bit pattern (bottom) by read circuitry. Double frequency coding is used: every bit cell starts with a clock pulse and a '1' cell contains a second pulse.

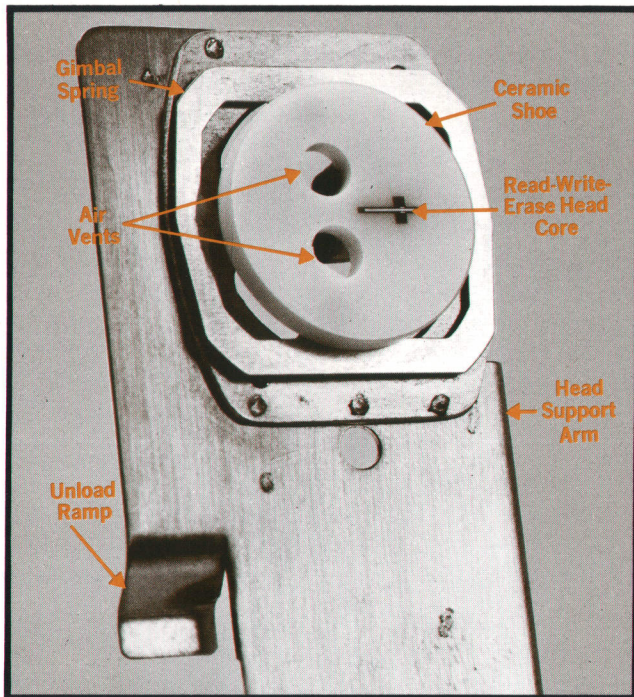



Fig. 3. The HP-developed read/write heads are critical to the drives' ability to operate between 10°C and 40°C. In-house production assures control of their characteristics.

at a height of 65 to 90 microinches above the disc surface when the drive is in operation. The heads follow irregularities in the disc and never touch the magnetic recording surface.

Making a head that would fly properly and read and write well under normal conditions turned out to be relatively easy, even at the high recording density of 2200 bits per inch. What was difficult was first to develop a head that would operate reliably over a wide range of environmental conditions, and then to set up and control the process of making the heads. The heads were the most critical element in meeting the environmental specifications. With microinch tolerances involved, even small temperature and humidity changes tend to cause significant shifts in the geometry of the head.

Heads meeting the strict environmental requirements of the 7900 Series could not have been purchased and so were developed in-house. This gave complete control of their characteristics and assured compatibility with the data electronics. It also provided a valuable understanding of head problems for the designers of the drive.

After considerable experimentation with materials and geometry, a head design was arrived at that meets the requirements of the 7900 Series. Representative heads have successfully read and written 10^{11} bits without any errors. 

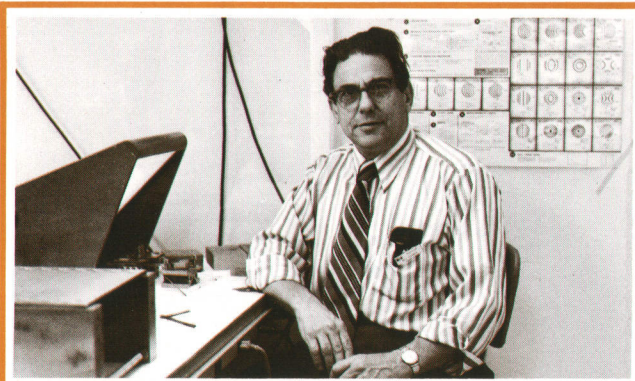

William I. Girdner

Bill Girdner came to HP in 1939 with an AB degree in physics and mathematics. Over the past 33 years he's been involved in tooling, in production management, and in development engineering. He holds several patents related to tape recorders, production machinery, and magnetic heads. Bill was project leader for the development of the wide-temperature-range heads for the 7900A and 7901A Disc Drives.



Wallace H. Overton

Wally Overton started out with HP as a lab and production technician in 1960. He's been concerned with magnetic recording development since 1964 and with disc drives since 1969. He contributed the read/write electronics to the 7900A and 7901A. Last year he received his BSEE degree from San Jose State College after 12 years of part-time study. Wally's an amateur photographer who has his own darkroom at home. The kind of photograph he likes to take may be implied by his favorite vacation activity, traveling with a trailer hitched to his car. He's toured the Canadian Rockies twice that way.



An Efficient Disc Drive/Computer Interface

The I/O structure minimizes bulk, system cost, and computer overhead, but doesn't get in the way of drive performance.

By Donald J. Bowman

THE PRINCIPAL feature of the input/output structure of 7900-Series Disc Drives is the partitioning of the interface circuitry between the disc drive and the controller so all of the drive's capabilities are fully used but expensive redundancies are avoided. The partitioning eases the task of interfacing and provides considerable flexibility to accommodate differing applications and future developments. Cabling is kept to a minimum to eliminate bulk and expensive connectors.

An eight-line output bus and a five-line input bus shared by several types of signals are the key to minimizing the number of interface lines (Fig. 1). The bus-oriented I/O structure makes it straightforward to operate up to four drives from one controller. Two more lines are eliminated by including simple decoding logic in each drive so a

drive can be selected by a two-line binary code instead of by an individual line for each drive.

Bus Carries Addresses and Control

Three levels of addressing specify the locations of data on the disc (Fig. 2). Radial location is specified by an 8-bit cylinder address. Angular location with respect to a reference position is specified by a 5-bit sector address. The disc surface is specified by a 2-bit head address. The sector is the smallest addressable block of data.

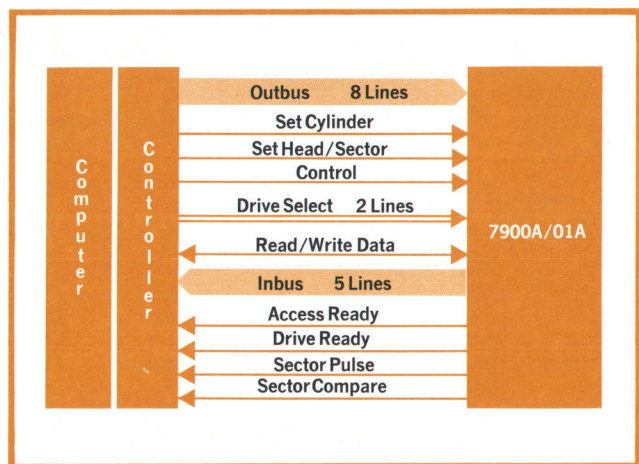

Fig. 1. Interface circuits are partitioned between drive and controller so expensive redundancies are avoided without loss of performance. Bus structure minimizes number of cables.

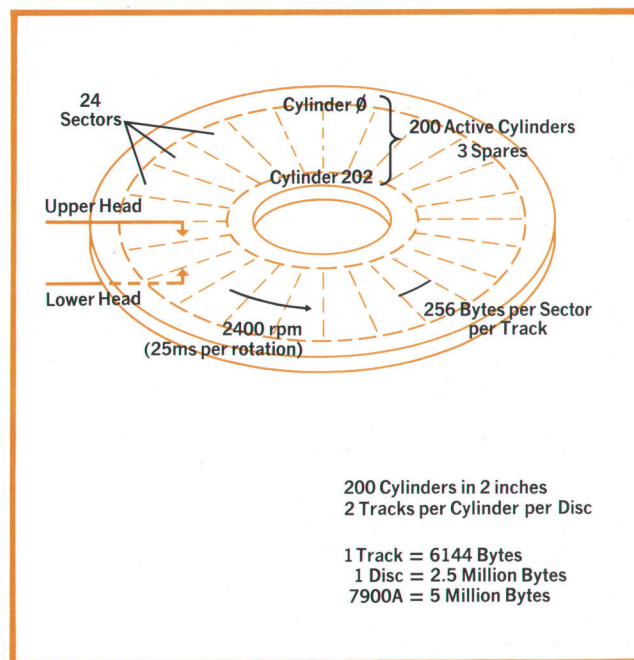

Fig. 2. Data locations on disc are specified by head, cylinder, and sector. Each sector contains a zero field, a sync word, sector verification, a 256-byte data field, and a cyclic error-check word.

The eight-line bus between the controller and the drive carries cylinder, sector, and head addresses, and certain control signals. To gate the information on the bus to the proper circuits in the drive, three signals are provided on separate lines: set cylinder, set head/sector, and control.

Set cylinder is a pulse which transfers the contents of the bus into the cylinder address register of the selected drive. Direct addressing is used, so no address computation is required outside the drive. The first 203 of the possible 256 addresses are legal cylinder addresses. Validity of the cylinder address is determined in the drive and status is sent back to the controller, thereby eliminating a validity check on the cylinder address word in the controller.

Set head/sector is a pulse which transfers the contents of the bus into the head and sector registers of the selected drive. Direct addressing is also used for the addresses and again the validity of the information is tested in the drive.

Since there is no transferring of address information to the drive while its memory control functions are being exercised, the same eight lines can be used to gate the memory control functions. The separate control signal is used to gate the read enable, write enable, erase enable, status enable, or attention enable signals from the bus to the appropriate circuits in the selected drive.

Status Takes the Other Bus

The five-line bus between the drive and the controller is used to transmit status and drive attention information that needn't be available to the controller at all times. The drive attention information is useful for performing overlapping seeks for efficient program execution. Information to be transmitted by the five-line bus is gated by control and gate status or gate attention signals from the eight-line bus.

Status information needed by the controller on a continuous basis is transmitted on separate lines. This information includes drive ready, access ready, sector pulse, and sector compare signals. The sector compare signal indicates when the sector counter within the drive compares with the sector address register in the drive. After addressing a sector, the computer is free to do other things until the sector compare signal indicates the desired sector is under the head. This makes for a more efficient system.

To reduce rotational delay in the 7900A, each drive has two sector counters, one for the fixed disc and one for the removable cartridge. This provides sector address information on a real-time basis. When switching between discs, there's no need to wait for an index pulse to reset the counter—the current sector address is immediately available.

Data Formatting

The format of the data transferred to the disc drive is determined by the controller and not by the drive. Putting the formatting and data-separation circuitry in the controller helps to minimize the interfaced system cost by eliminating circuit redundancy. No flexibility or system performance is lost since only one drive in a chain can be in the process of transferring data. Gated differential line drivers and receivers are used to preserve the integrity of the data and to allow bidirectional data transfer.

As data is written, it is checked cyclicly and a cyclic check word is formulated. This word is written after the data field in each sector. When the sector is read, it is again checked cyclicly and the results are used to determine if an error occurred during the read operation. 

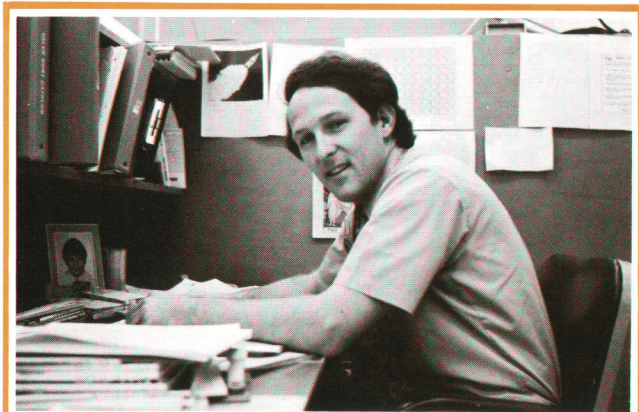

Donald J. Bowman

Don Bowman came to HP in 1969 with a background in logic design for video displays and communication systems. He's been responsible for interfacing the 7900A and 7901A Disc Drives to HP computers. He received his bachelor's degree in electrical engineering from California State Polytechnic College in 1966, and his MSEE degree from the University of Santa Clara in 1971. Apart from his career, Don's a regular participant in amateur volleyball and baseball, and a maker of rugs to be used as wall hangings in his home. Out of concern for our environment, he's volunteered to be 'neighborhood garbageman,' periodically collecting recyclable materials from his neighbors and delivering them to a recycling center.

Narrowband Noise Immunity in a Broadband Gain-Phase Meter

Phase response, as necessary as gain for complete understanding of circuit behavior, has often been ignored for reasons of convenience. A new Gain-Phase Meter, with its attach-and-read operating simplicity, promises to make phase measurements as routine as voltage measurements. Despite its broad bandwidth (1 Hz to 13 MHz), the new instrument has much of the ability of narrowband phase-meters to suppress the effects of noise.

By Raymond C. Hanson

COMplete characterization of electronic devices and networks in the frequency domain requires two fundamental measurements: gain and phase. Instruments for making both measurements are widely used at high frequencies and indeed, their use has revolutionized microwave circuit design. Phase information at lower frequencies, on the other hand, has been a little harder to come by so the better understanding that phase information can provide often is not attainable.

Not that there is a lack of phasemeters—several are available. All use the same basic technique: measure the time interval between the zero crossings of two signals and relate the result to the total waveform period. This can be accomplished by gating on a flip-flop at the zero crossing of one signal and gating it off at the zero crossing of the other. The average value of the flip-flop output is directly proportional to the phase difference between the two signals (Fig. 2).

This technique, however, is highly susceptible to errors caused by noise. Noise introduces additional positive- and negative-going zero crossings as the signal goes through zero. This can shift the point where the flip-flop triggers and might even cause the flip-flop to trigger on the wrong sense of the signal. For example, a flip-flop designed to trigger on positive-going slopes could trigger on the negative-going slope when noise adds a positive-going crossing, as shown in Fig. 3. A 180° error is thus introduced.

Some phasemeters overcome this problem by using narrowband filters to remove distortion from the signal, usually in a superheterodyne-type circuit that uses IF filters. This means either considerable tedium for the operator, making tuning adjustments

each time the signal frequency is changed, or the use of a phasemeter specially designed to work with a particular signal source that has appropriate tracking signals.

The broadband approach is thus attractive because of its simplicity. It is also less expensive. This approach has been appropriate for many applications but it has required clean signals (better than 50 dB S/N ratio).

Now there is a new phasemeter, one that is broadband, i.e. does not need to be tuned, but that is far less susceptible to noise. For example, with a 10-kHz sine wave so mixed with 100 Hz–1 MHz Gaussian noise as to give a 30 dB S/N ratio on one channel, and a clean 10-kHz sine wave on the other, a phase measurement with this instrument would be in error less than 2°.

Dual Function

In addition to measuring phase, the new Gain-Phase meter (Model 3575A) measures gain, presenting results directly in dB units so it is very easy to make Bode plots of transfer functions simply by reading gain and phase for each frequency. Not only is there no need to tune the Gain-Phase Meter*, but the signal source does not have to be leveled or calibrated at each frequency—the Gain-Phase Meter automatically determines the amplitude ratio of the two signals being measured.

If a sweeping signal source is used, gain and phase vs frequency can be plotted directly with the Gain-Phase Meter and an X-Y plotter. The Gain-Phase Meter has analog outputs proportional to phase and to the logarithm of gain. As an option,

*The function of the front-panel FREQUENCY RANGE switch is to select broadband filters that remove noise frequencies outside the selected range.

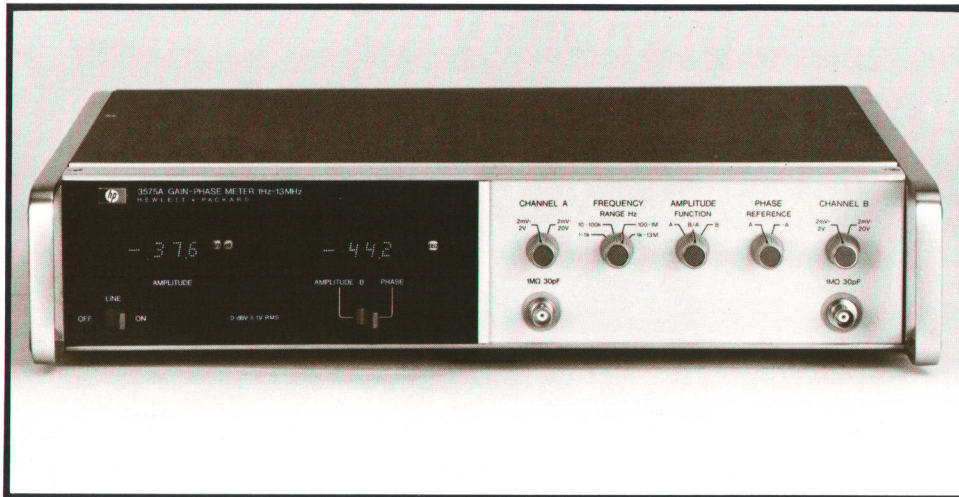

Fig. 1. New HP Model 3575A Gain-Phase Meter measures amplitude ratio and phase difference between two signals in 1 Hz–13 MHz frequency range. Optional version shown here has two digital readouts. Standard version has left readout only and switch selects gain or phase for display. Other options provide for external digital control and readout of all functions for systems use.

the instrument also has BCD outputs for printers or computers. That option also provides for computer control of the Gain-Phase Meter.

The new Gain-Phase Meter works in two amplitude ranges and has an 80-dB dynamic range in each range (0.2 mV–2 V, 2 mV–20 V). Because each input has its own attenuator, the instrument can measure signals with an amplitude difference as great as 100 dB. The inputs are compatible with commonly-available oscilloscope probes so these may be used when circuit loading is a problem or when it is desirable to extend the amplitude range to 200 V.

Digital Readout

Measurement results are displayed digitally. This gives a resolution of 0.1° in phase and 0.1 dB in gain, making it possible to discern fine detail in the gain and phase response curves. The instrument can also read absolute amplitude in units of dBV, where 0 dBV = 1 volt rms, with an accuracy of ± 1 dB up to 1 MHz. For phase, accuracy is $\pm 0.5^\circ$ up to 20 kHz, going to $\pm 5^\circ$ at 1 MHz (full details are on page 20).

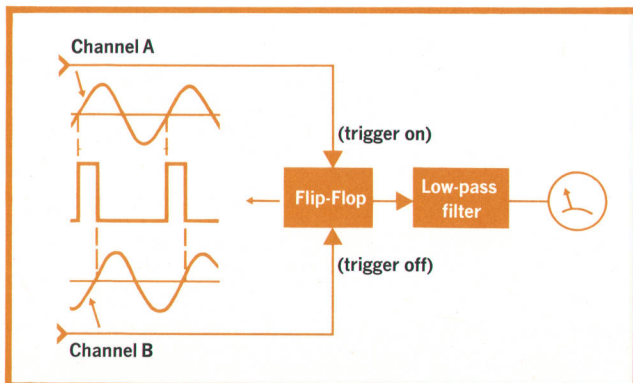

Fig. 2. Phasemeter responds to ratio of time difference between waveform zero crossings to total waveform period.

Impure Signals

During phase measurements, signal distortion has no effect on readings in certain cases but can affect the reading at other times. In-phase harmonics, such as those found in square and triangular waves, do not affect the waveform zero crossings and thus do not give ambiguous readings.

Phase-shifted even harmonics cause a dissymmetry in the waveform. This would be a source of errors but it is eliminated in the Model 3575A by the use of two phase detectors, one that responds to positive-going zero crossings and one that responds to negative-going crossings. The phase detector outputs are summed and averaged to cancel the error.

Phase-shifted odd harmonics, on the other hand cause errors that are not so easily eliminated. The worst case occurs when an odd harmonic is in quadrature, reaching its peak value as the fundamental goes through zero. The resultant shift in zero crossing is determined by:

$$E_1 \sin \theta = E_n \cos n\theta$$

where E_1 is the amplitude of the fundamental, E_n is the amplitude of the n^{th} harmonic, and θ is the shift in zero crossing.

For θ small, this equation reduces to

$$E_1 \theta \approx E_n$$

or,

$$\theta \approx \frac{E_n}{E_1} \text{ radians}$$

For $E_1 = 100E_n$, or harmonic distortion 40 dB below the fundamental, $\theta = 0.01$ radians or 0.57 degrees at worst. For moderate odd-harmonic distortion levels, then, any broadband phasemeter can give good answers.

Noise Pollution

Noise is a far more serious problem for the broadband phase detector. The problem is not easily described in terms of signal-to-noise ratios because a

pronounced threshold effect exists—any time that noise peaks are large enough to cause false triggering of the phase detector, serious errors can result. Suppose a phasemeter were designed to respond to

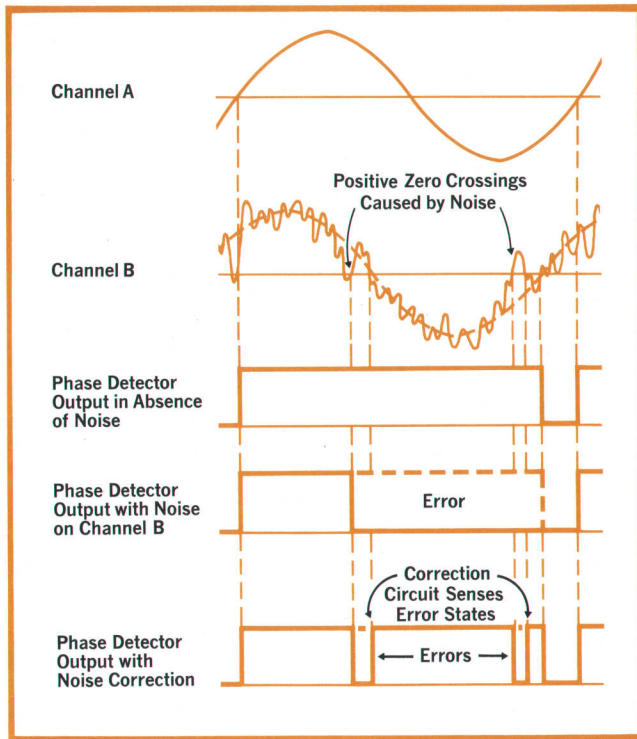

Fig. 3. Noise of enough amplitude to cause false triggering in phase detector can introduce serious errors in phase measurements. Correction circuit in new Gain-Phase Meter resets falsely triggered phase detector when waveform re-crosses zero.

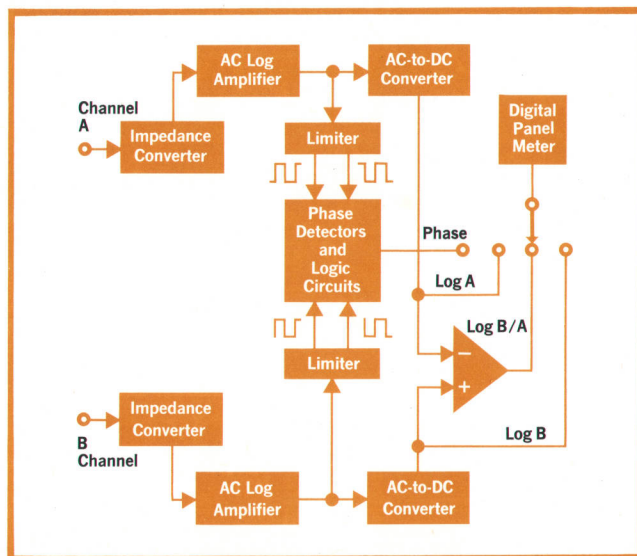

Fig. 4. Simplified block diagram of Model 3575A Gain-Phase Meter.

1-mV signals and to accommodate a 60-dB dynamic range. Noise 60 dB below a 1-volt signal could then cause false triggering.

How does the new Gain-Phase Meter cope with this problem? By looking at the logic of the situation. The two phase detector outputs can be considered as binary variables dependent on the input signals, and the input signals themselves can be treated as binary variables.

These four binary variables have sixteen possible states, eight of which are caused only by false triggering of the phase detectors. The instrument has eight quad input gates connected to the four binary variables so that when any one of the eight error states occurs, one of the gates gives an output. This output is used to trigger the phase detector at fault into its proper state. High-speed logic is used so a phase detector is in a wrong state for only a small fraction of a period, as diagrammed in Fig. 3. Hence only a small error results.

Wide Dynamic Range

As shown in the block diagram of Fig. 4, the Model 3575A uses logarithmic amplifiers to reduce the range of signal amplitudes. Only one limiting amplifier is needed to derive constant-level square waves for driving the phase detector. The outputs of the logarithmic amplifiers are also fed to averaging detectors that produce dc voltages proportional to the logarithm of the corresponding input.

Applying the dc from each channel to a differential amplifier then produces a signal proportional to the logarithm of input B minus the logarithm of input A, or $\log(B/A)$. This is proportional to gain in dB.

Since the two channels are independent, the gain function can be obtained for signals that do not have the same frequency, a capability that can be used for such purposes as measuring mixer gain.

The log amplifiers are hybrid thin-film devices that use the nonlinear portions of the transfer characteristics of several transistor stages to derive the overall logarithmic transfer function. A computer-controlled test system trims the thin-film resistors with a laser beam to establish the optimum bias levels for the transistors and to establish gain. By this means, a gain accuracy of ± 1 dB is obtained over the wide dynamic and frequency ranges.

Acknowledgments

Much of the control logic and circuit design, including the broadband amplitude detector, was the responsibility of David Deaver. The functional and aesthetic package was designed by Dennis Coleman.

Tom Baker contributed the 13-MHz log amplifier with its associated resistor-trim computer program, a significant technical contribution. Tom Rodine

was responsible for another significant development, the 13-MHz phase detector and noise-detection technique. 

SPECIFICATIONS

HP Model 3575A Gain-Phase Meter

PHASE

RANGE: $\pm 180.0^\circ$.
PHASE REFERENCE: Channel A or A-180° (-A).
SIGNAL LEVEL: 20 μ V to 20 V rms.
PHASE ERROR (analog output)

CHANNEL B INPUT RANGE (with 2 V input on Channel A)

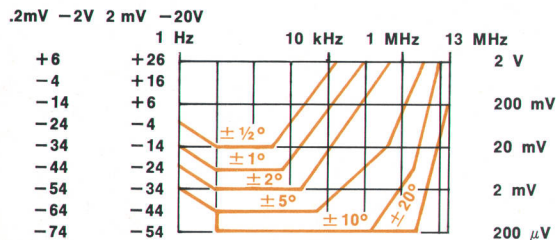

Temperature, 20°C to 40°C; frequency range switch on lowest applicable range.

AMPLITUDE

INPUT RANGE (Channels A and B):
100.0 dB (200 μ V to 20 V) in two ranges
(+6 to -74 dBV, +26 to -54 dBV).
B/A RATIO RANGE (display range): +100 to -100 dB.

PRICES IN U.S.A.

HP 3575A, \$2450.
Opt 001, dual readout; add \$400
Opt 002, programmability; add \$720

AMPLITUDE ERROR (analog output); parentheses denote ratio errors:

CHANNEL A or B INPUT RANGE

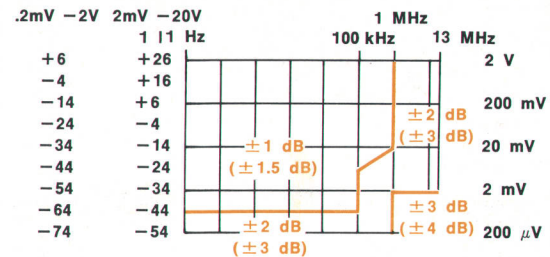

Temperature, 25°C $\pm 5^\circ$. For ratio measurements, lowest level channel determines accuracy.

INPUTS

IMPEDANCE: 1 M Ω , <30 pF.
FREQUENCY RANGE (input filter response):
1 Hz to 1 kHz. 100 Hz to 1 MHz.
10 Hz to 100 kHz. 1 kHz to 13 MHz.

OUTPUTS

PHASE: 10 mV/degree.
AMPLITUDE: 10 mV/dB.
DIGITAL READOUT:
3½ digits with sign and annunciators.
0.1° phase and 0.1 dB amplitude resolution.
Contribution to total error: ± 0.3 units
4 per second reading rate.

GENERAL

POWER: 115/230 V $\pm 10\%$, 48-440 Hz, 40 W.
WEIGHT: Net 20½ lbs. (9.3 kg).
DIMENSIONS: 16¾" x 18¾" x 3½" (425 x 467 x 88 cm).



Raymond C. Hanson

The new Gain-Phase Meter is Ray Hanson's third instrument to be described in these pages. First was the Model 3410A AC Microvoltmeter (May 1967), then the Model 3310A Function Generator (June 1969).

Now in his tenth year at Hewlett-Packard's Loveland Division, Ray came west to Colorado primed with experience gained designing voice-frequency test equipment at the Bell Telephone Laboratories. He had started out further west, however, earning a BSEE degree at the University of California at Berkeley in 1959. His MSEE is from New York University (1961).

HEWLETT-PACKARD JOURNAL
MAY 1972 Volume 23 • Number 9



Technical Information from the Laboratories of
Hewlett-Packard Company, 1501 Page Mill Road,
Palo Alto, California 94304 U.S.A.
Hewlett-Packard S.A., 1217 Meyrin—Geneva, Switzerland
Yokagawa-Hewlett-Packard Ltd., Shibuya-Ku, Tokyo 151 Japan

Editorial Director: Howard L. Roberts
Managing Editor: Richard P. Dolan
Contributing Editors: Ross H. Snyder, Laurence D. Shergalis
Art Director, Photographer: Arvid A. Danielson
Art Assistant: Erica R. Helstrom
Administrative Services: Ruth G. Palmer